



# ECLIPSE - RIDER



**USER MANUAL**



VER. 1.34 – ENG

© Copyright by **FLY Products** s.r.l.

Via Perù n. 30 - 63066 GROTTAMMARE (AP) - ITALY

Tel. +39.735.632486 - [www.flyproducts.com](http://www.flyproducts.com) - ✉ [fly@flyproducts.com](mailto:fly@flyproducts.com)



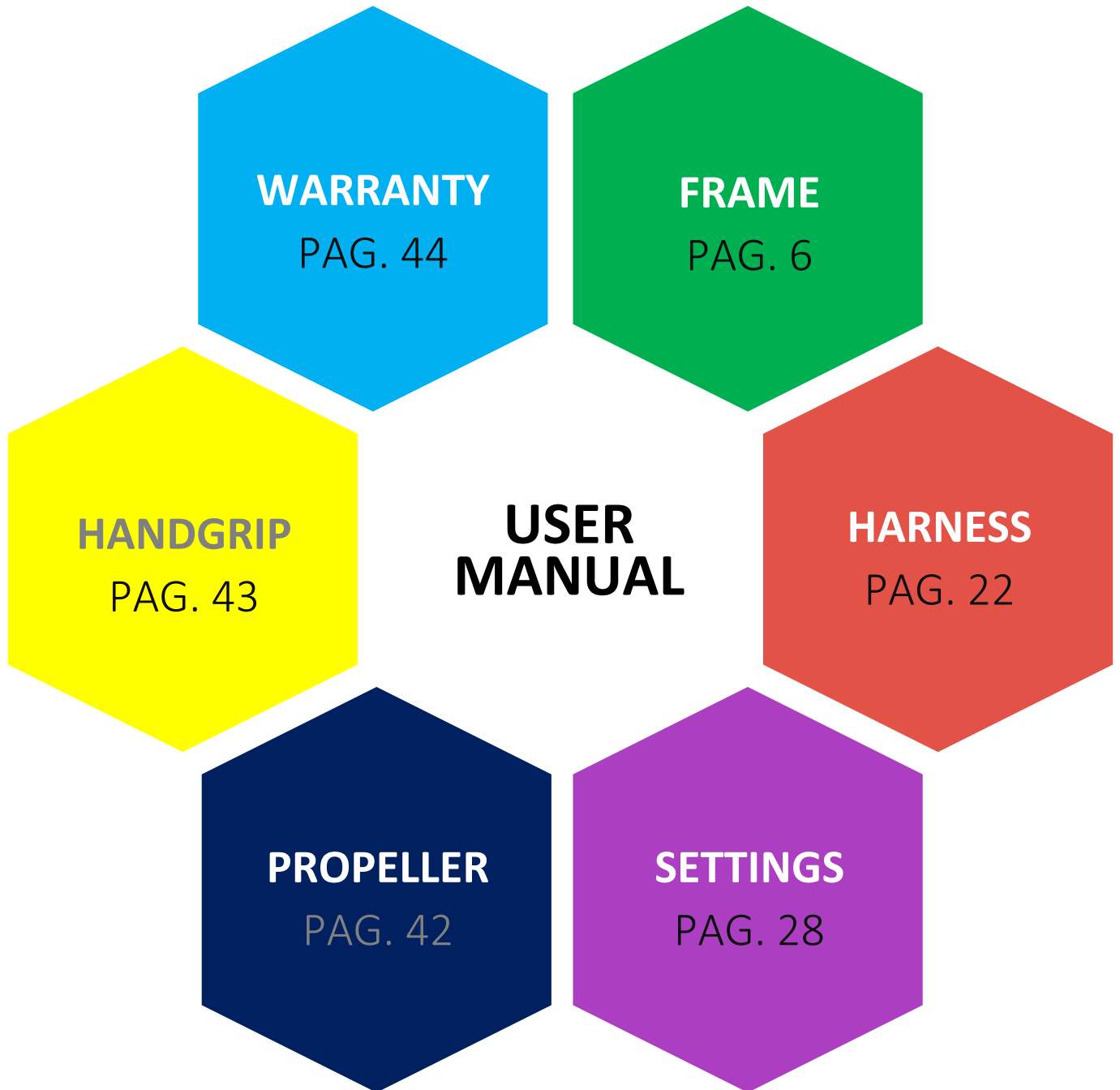

## FIRST SAFETY! - WHO, WHERE AND WHEN CAN FLY IT.

Powered Para Gliding (PPG) is the most exciting, least expensive, safest and most accessible form of aviation available! However, it is still aviation, and carries with it all the potential inherent dangers of aviation, which is why it is imperative that prior to flying with this PPG it is necessary to receive adequate training from qualified instructors and obtain a valid PPG license. Give the Paramotor the attention that all the aviation deserves, to respect the norms, the weather conditions and to realize that the pilot who is fully responsible for his own safety and for the safety of fellow pilots and bystanders. Depending on each national regulation, the Paramotor can only be used in authorized areas and flights within controlled airspace usually require an authorization issued via radio, furthermore additional requirements such as a valid insurance must be met.

Because of the inherent risks in flying any Paramotor, no warranty of any kind can be made against equipment failures, accidents and even fatal injuries.

**This Paramotor is not covered by product liability insurance.**

## Used Notations

In this manual, we will use some special terms for notations:

(**NOTE**, **ATTENTION**, **WARNING**) Their use is defined below.

A **NOTE** provides additional information to help clarify a point that is made in the text. Generally, a **NOTE** is provided to facilitate product assembly, use or maintenance. Ignoring a **NOTE** could cause inconvenience but not cause damage or personal injury.

The **CAUTION** notation provides additional information to help clarify an area where equipment damage could occur. Failure to observe a **CAUTION** can result in permanent and significant mechanical damage; however, it is unlikely to cause personal injury.

A **WARNING** provides additional information to help clarify an area where failure to follow a **WARNING** can result in serious injury or even death.

## ECLIPSE and RIDER features

FLY PRODUCTS presents these very light, but robust, Paramotors whose features are great versatility and ease in disassembly and assembly.

## Overall dimensions

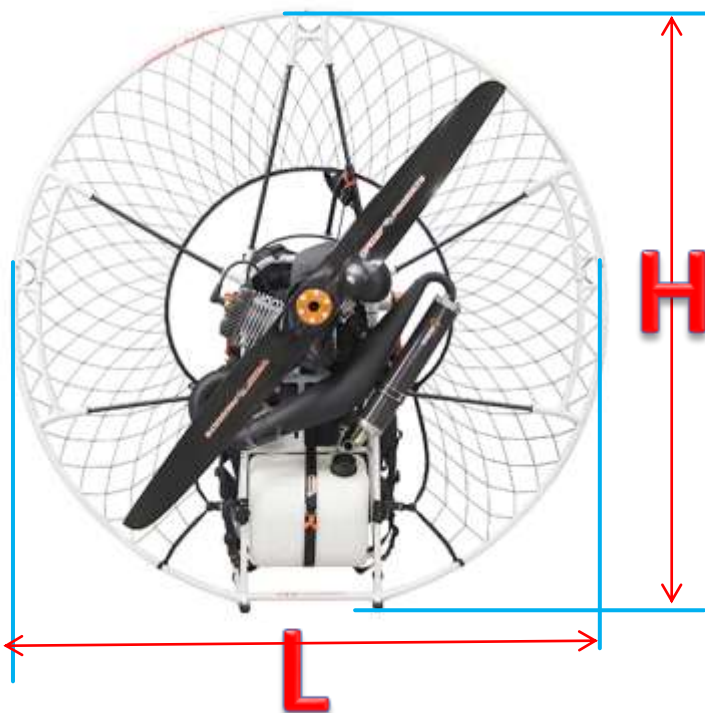

MODEL	H(cm/in.)	L(cm/in.)
ECLIPSE (MAX PROPELLER 130)	142/55.9	142/55.9
RIDER PROPELLER 130 MONO RIM	146/57.5	144/56.7
RIDER PROPELLER 130 DOUBLE RIM	150/59.0	143/56.3
RIDER PROPELLER 140 MONO RIM	153/60.2	153/60.2
RIDER PROPELLER 140 DOUBLE RIM	155/61.0	155/61.0

S(cm/in.)
Engine <b>ATOM</b> = 45/17.7
Engine <b>MOSTER</b> = 42/16.5
Engine <b>THOR 202</b> = 50/19.6

\* Note: central frame RIDER can fit all RIDER configurations:

- mono/double rim for 130 cm/51.1 in. propeller
- mono/double rim for 140 cm/55.1 in. propeller



The Paramotor can be disassembled, folded and inserted into the special trolley (**optional**) to be easily stored, transported or even shipped.

The trolley sizes are:

- cm 100 x 57 x 40 (in. 39.3 x 22.4 x 15.7)  
\* for max 130 propeller models
- cm 115 x 57 x 40 (in. 45.3 x 22.4 x 15.7)  
\* for max 140 propeller models

## FRAME ASSEMBLY



The engagement system used "clip button" or snap button, greatly simplifies the assembly procedure.

For a correct use, keeping the button pressed, engage the two parts and rotate them slightly until the clicking button comes out of the hole.

For disassembly, just keep the button pressed down until doing a slight pull and rotation until the hole is released from the button thus allowing the separation of the two parts.

The supports of the cage to be mounted on the central frame are of THREE different lengths as shown in the figure:

- A:** LONG – *up*
- B:** AVERAGE – *center*
- C:** SHORT – *low*

The other removable part: **D** It is the starter support for housing the engine starting pulley.

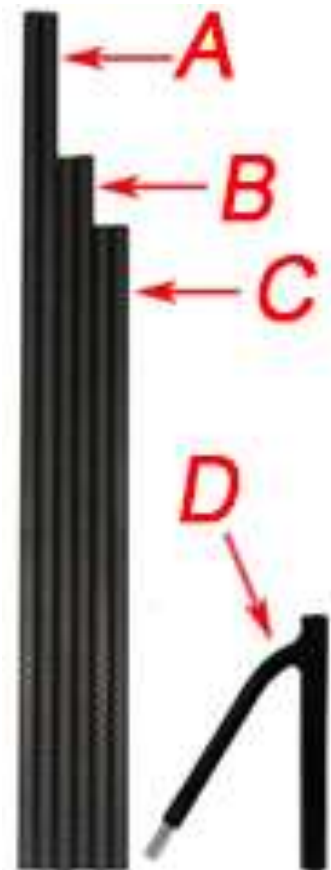

### NOTICE

JUST THE FIRST ASSEMBLY, AS THE NET IS NEW, IT IS NORMAL TO EXERCISE A GREATER FORCE THAN USUAL IN ASSEMBLING THE PARTS. YOU CAN PROCEED WITHOUT FEAR OF DAMAGE.



**To start:** Insert the starter support “D” on the central engine frame first.

- 1) Hook the starting pulley on the starter support as shown in the figure.
- 2) Insert the **LONG (A)** rods in the central frame.

**NOTE :** Pay attention to the correct pulley positioning inside the support.



Complete the insertion of the rods according to the length, as previously indicated, in the appropriate housings:

- (A) LONG rods
- (B) MEDIUM rods
- (C) SHORT rods

Begin assembling the outer frame circle by following the procedure:

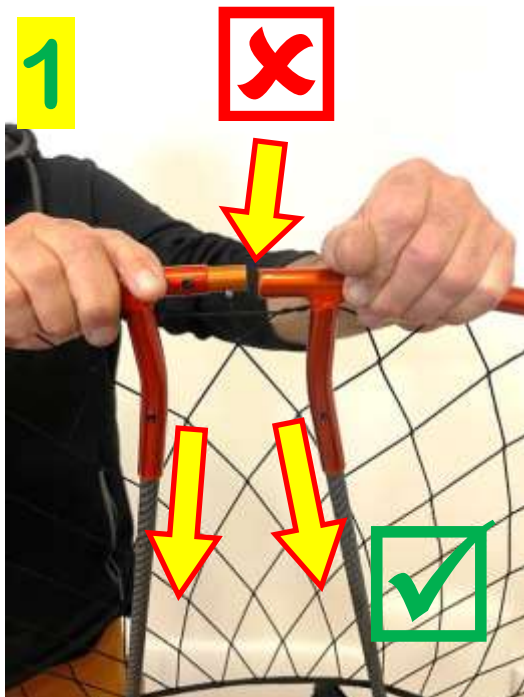

1

Thread the two upper parts of the cage **without joining them together**, the connection will be made after inserting the remaining parts of the cage.

2-3

Insert the two parts of the cage, right and left, into the MEDIUM rods (B) by slightly forcing the rods upwards to facilitate the operation.



4-5 Insert the two lower parts of the circle, right and left, into the SHORT rods (C) by slightly forcing the rods upwards.





**6-7**

Once all the insertions of the external frame into the slats have been completed, proceed to the lower RIGHT and LEFT coupling, checking that the sealing button has come out correctly from its hole and the part is actually locked.

**8-9**

Then proceed to the RIGHT and LEFT lateral connection of the two lower and upper semicircles, checking that the sealing button has come out correctly from its hole and that the part is actually locked.

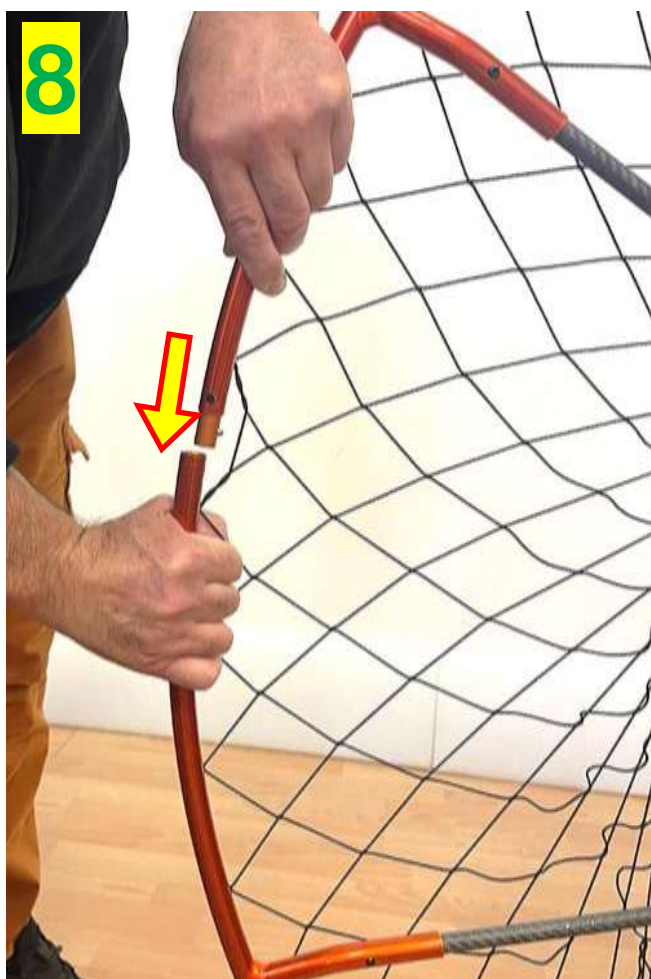



# 10

Connect the two upper semicircles together, always checking that the sealing button has come out correctly from its hole and that the coupling is actually firm.

To complete the assembly of the cage, hook the RIGHT and LEFT side velcro straps as follows:



Open the velcro and pass it through the prepared eyelet following the direction indicated.



Pull the velcro until you have the maximum tension of the net.

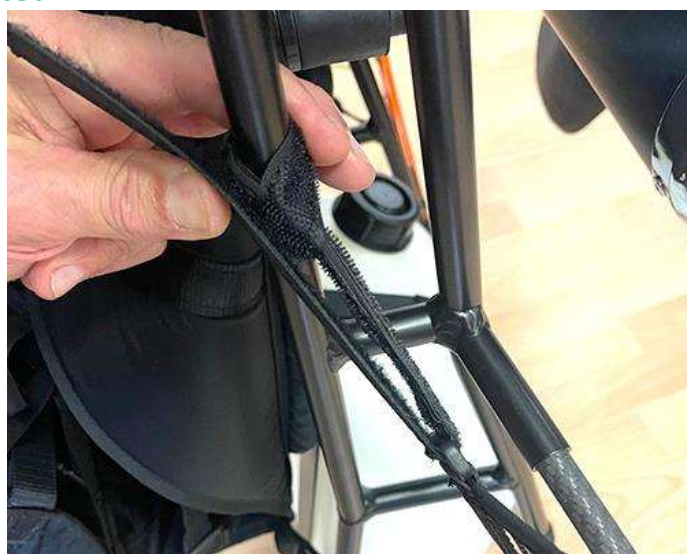

Lock the velcro in correct position by pressing it on the underlying loop.

Turn the velcro around the loop and lock it properly in place.

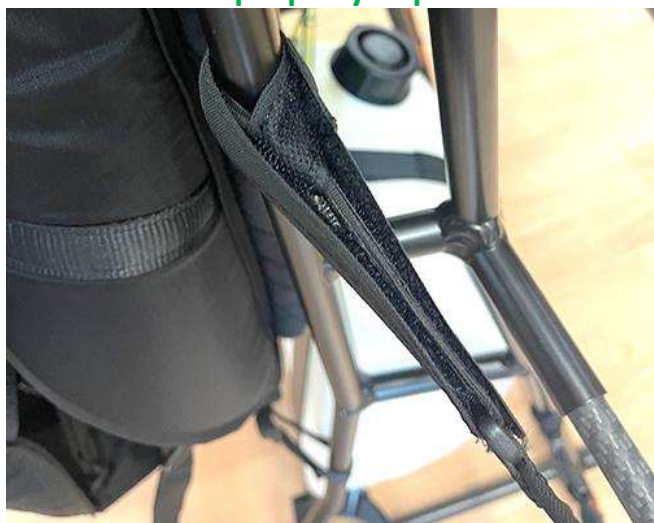

Firmly tighten parts to ensure complete matching.



**REPEAT THE SAME OPERATION ON THE OTHER SIDE**

Finally, join the lower plastic buckles to fix and perfectly stretch the net:



Hook the parts making sure the buckle is perfectly sealed.



Lock the coupling by moving the button as shown in the figure.

**REPEAT THE SAME OPERATION ON THE OTHER SIDE**

**This operation ends the assembly of the protection cage.**

## CAGE DISASSEMBLY

To disassemble the cage avoiding to force some parts too much and avoid possible damage, we recommend proceeding with the following sequence of operations:

1-3

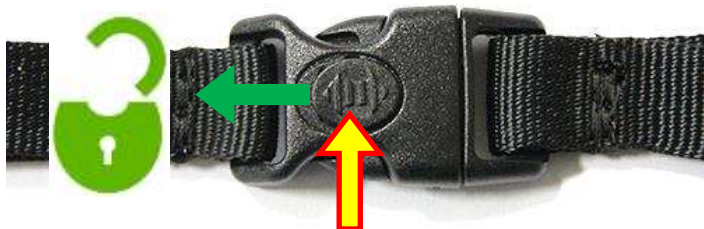

1-2

3-4

Start by unlocking the safety of the lower plastic buckle and unlock it, repeat the same operation on the other side before continuing.





## 5-6

Unlock and release the net from the RIGHT and LEFT side velcro straps, taking care to **close the velcros on itself**.

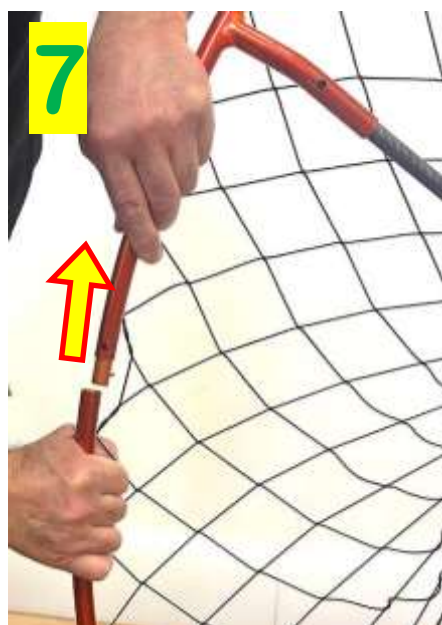

## 7-8

Uncouple the upper cage from the lower one by pressing the push-pin button and pulling the upper part upwards.

**Repeat the operation on the other side**

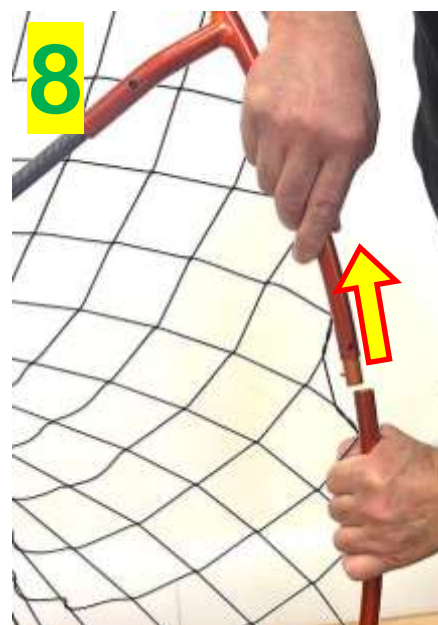

## 9

Uncouple the upper cage by pressing the push-pin button and pulling the parts in the opposite direction.

**DO NOT REMOVE NOW from the support rods !**

## 10-11

Unhook the lower cage by pressing the push-pin button and pulling the part outwards.

**Repeat the operation on the other side**



## 12-13

Slide the lower cage out of the rods while holding them firmly in place.

**Repeat the operation on the other side**



## 14-15

Remove the upper SIDE cage from the rods, holding them firmly in place.

**Repeat the operation on the other side**



## 16

Join together the two plastic buckles of the disassembled net below.



## 17

Lift the two lower semicircles to the top with the nets joined by the plastic buckles and hold the four parts at the same time before removing.

## 18-19

Remove the last two semicircles from the rods and fold everything in a booklet so that the cage is ready and folded in the correct way to put it back in its bag.



**This operation ends the disassembly of the cage.**

## STORAGE OF THE CAGE



Place the rods in the special pocket inside the bag prepared for this purpose, then put the cage already folded up carefully and close the bag with the string.





## RIDER SINGLE RIM FRAME

The assembly and disassembly operations of the single rim frame of the RIDER series are identical to the ECLIPSE frame, therefore it is advisable to follow the procedure explained above.



The only differences are the double upper attachment and the two double lateral attachments.



## RIDER DOUBLE RIM FRAME ASSEMBLY

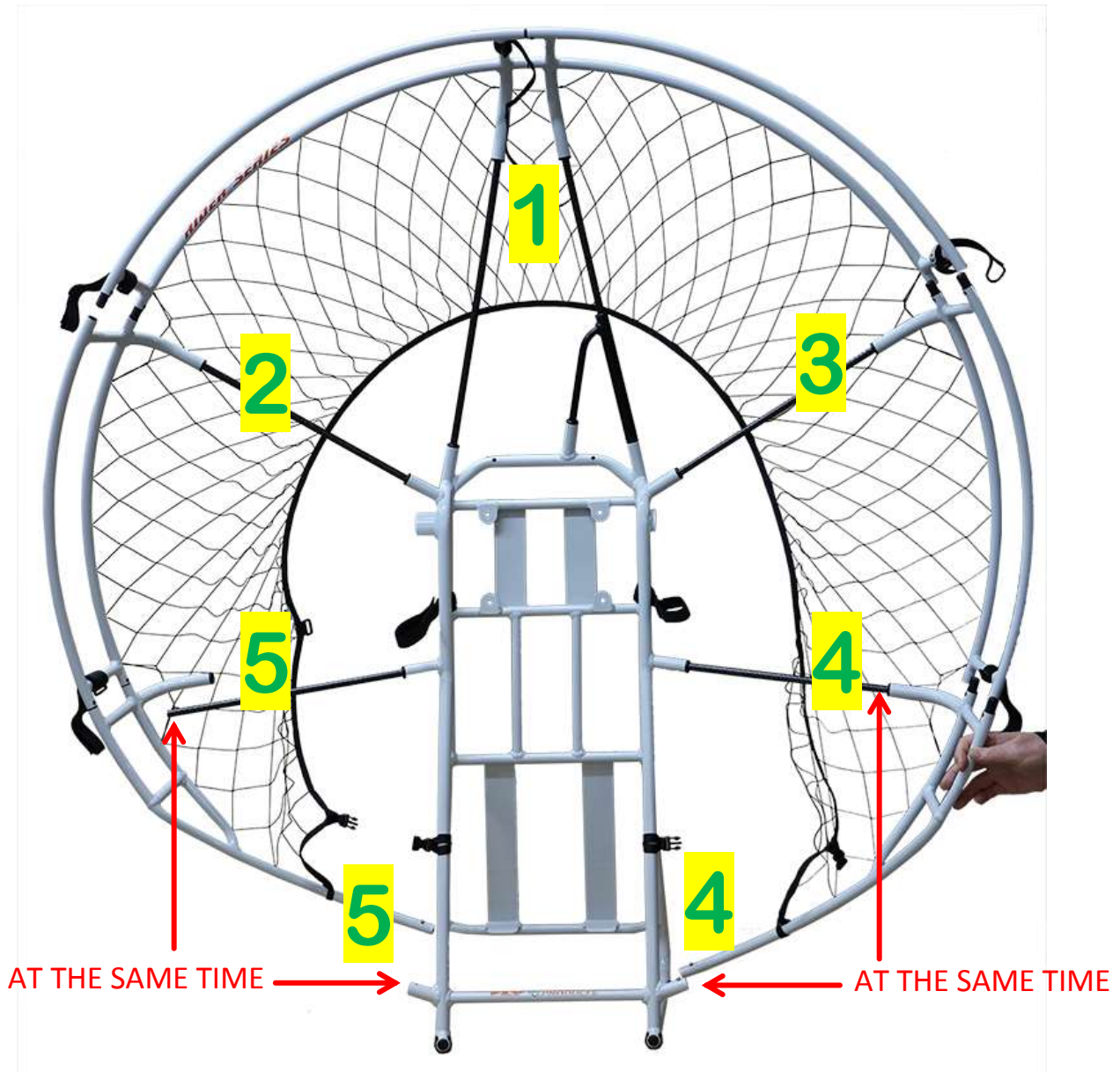

In order not to force the net excessively, it is recommended follow the illustrated sequence with the parts **DETACHED** from each other taking care to insert points "4" AT THE SAME TIME and finally again at the same time points "5" making sure the snap pins are perfectly inserted.

When all the parts are in place, you can proceed to the complete junction of the rim and the subsequent locking it with the prepared velcro straps.

## DOUBLE RIM RIDER FRAME DISASSEMBLY

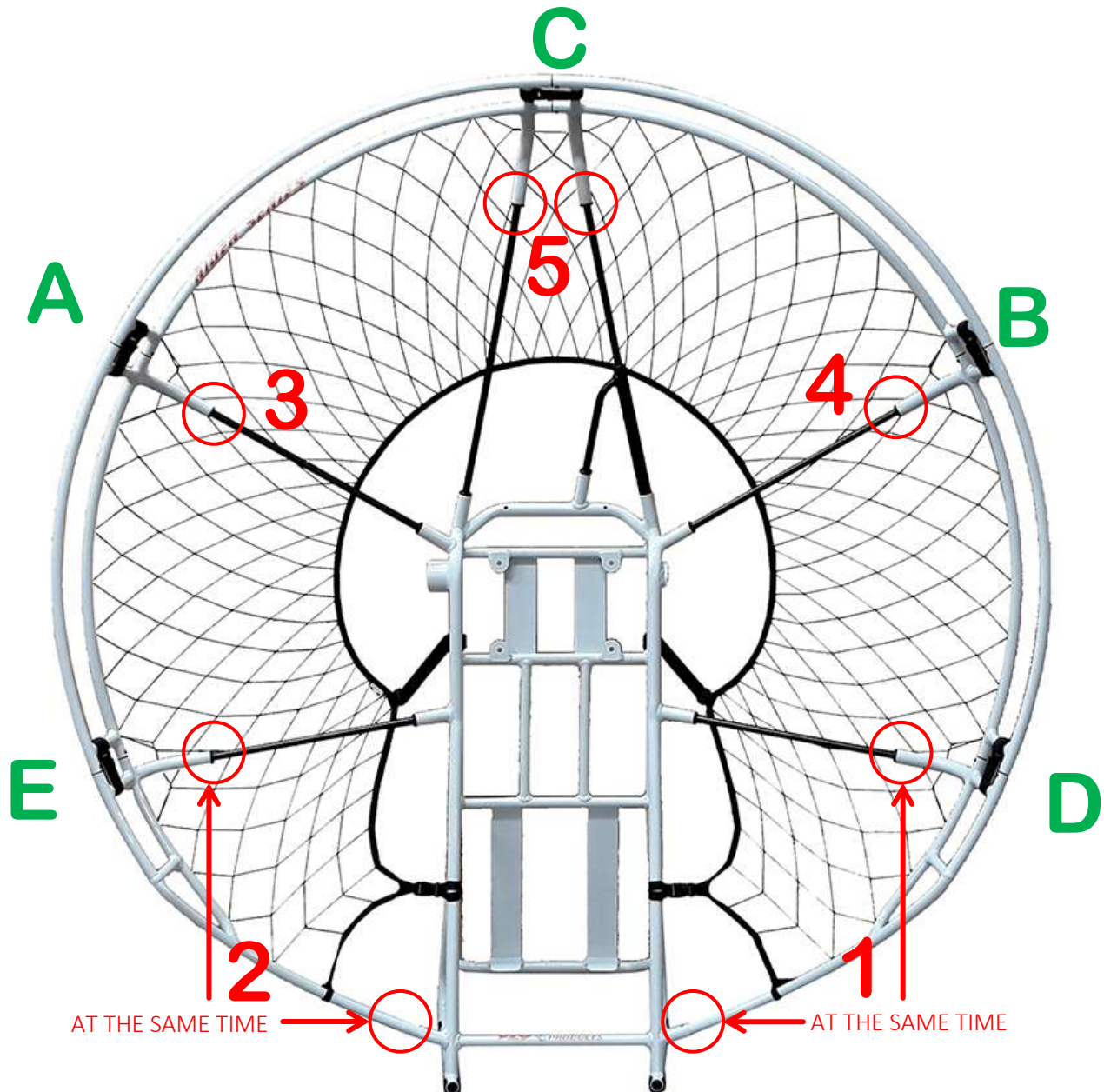

For disassembly, after opening all the closing velcro straps,  
**(it is good norm to close them on itself to prevent  
 they stick to the net in the subsequent operations)**  
 detach all the joints of the outer rim starting from points **A – B**  
 and continue with points **C-D-E**.

Then, following the order illustrated above, **PULL OUT** the parts from  
 the support ribs **1-2-3-4-5** taking care to remove **AT THE SAME TIME**  
 first points **"1"** and then again **AT THE SAME TIME** points **"2"**.

## MOUNT THE TANK



Turn the strap around the tube between the two velcroes, and close them to stop it. Place the tank in the correct position onto its supports and lock it as shown below.





Pass the belt inside the red eyelet, close it and lock it with the safety belt (S) as shown in the photo.



To release the tank, open the safety little belt (S), detach the velcro from the closure, release the red eyelet and pull it back to help the rings open.



## ECLIPSE HARNESS ASSEMBLY AND SETTINGS

Fit the harness by hooking it to the central frame using the two upper straps which have TWO different colored indicators to adapt it to the different sizes as shown in the photo:



Indicator

**RED**

FOR SIZES

**S**

**M**



Indicator

**BLUE**

FOR SIZES

**L**

**XL**



Store the straps away stopping them under the loops as shown in the photo.



Hook the middle side straps of the harness having as a reference the red seam as shown in the photo.



Hook the lower harness anchoring straps taking care to pass behind the leg of the frame and then under the lower bar as shown in the photo.

For correct assembly of pivot arms and for their adjustment of the weight balance of the pilot in flight position on the simulator, refer to the instructions on page 30.



Install the pivot arms in position and, taking care to line the holes, lock them with the push pins keeping the button pressed and releasing it only after it has completely entered. **Make sure the pushpin is secured.**



**ATTENTION**  
When installing the pivot arms, always be careful that the belt is in the correct position **and there are no twists.**



In the **light harness**, to avoid possible entanglement when disassembling the pivot arms, we recommend placing them in the appropriate slots.



It is possible to adjust the seat depth by removing or adding the extension attaching it on the prepared velcro.

## RIDER HARNESS ASSEMBLY AND SETTINGS



Insert the harness on the harness plate and lock the push-pin.



For a correct use of the push-pin, keep the button pressed while inserting and while closing the safety cap,  
**CHECK THAT IT IS LOCKED!**



Lock the four lower straps onto the quick-lock bucklets.



Hook the elastic rope of the starter handle to the prepared eyelet and lock it under the velcro for 5-10 cm. (2-4 In.)



Put the pivotarms in position and, taking care to keep the holes in axis, block them with the push pins.

**CHECK THAT THEY ARE LOCKED!**

## OPTIMAL ADJUSTMENTS



For a correct posture of the paramotor which must not be too close to the head nor too low to touch the legs, it is necessary to act on the **shoulder strap** adjustment by pulling or loosening them enough to obtain the right position.



# ADJUSTMENTS TO THE SIMULATOR

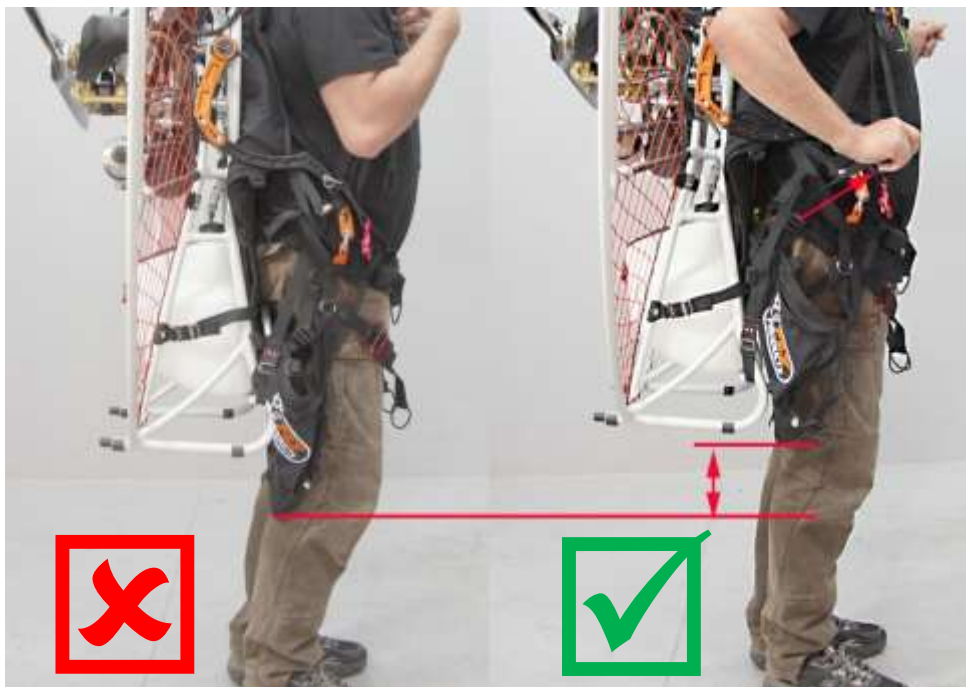

Harness height adjustment to facilitate the takeoff run.

Height adjustment of the seat to facilitate the take-off run through the **SEAT HEIGHT STRAPS** adjustment (NO SHOULDER STRAPS)

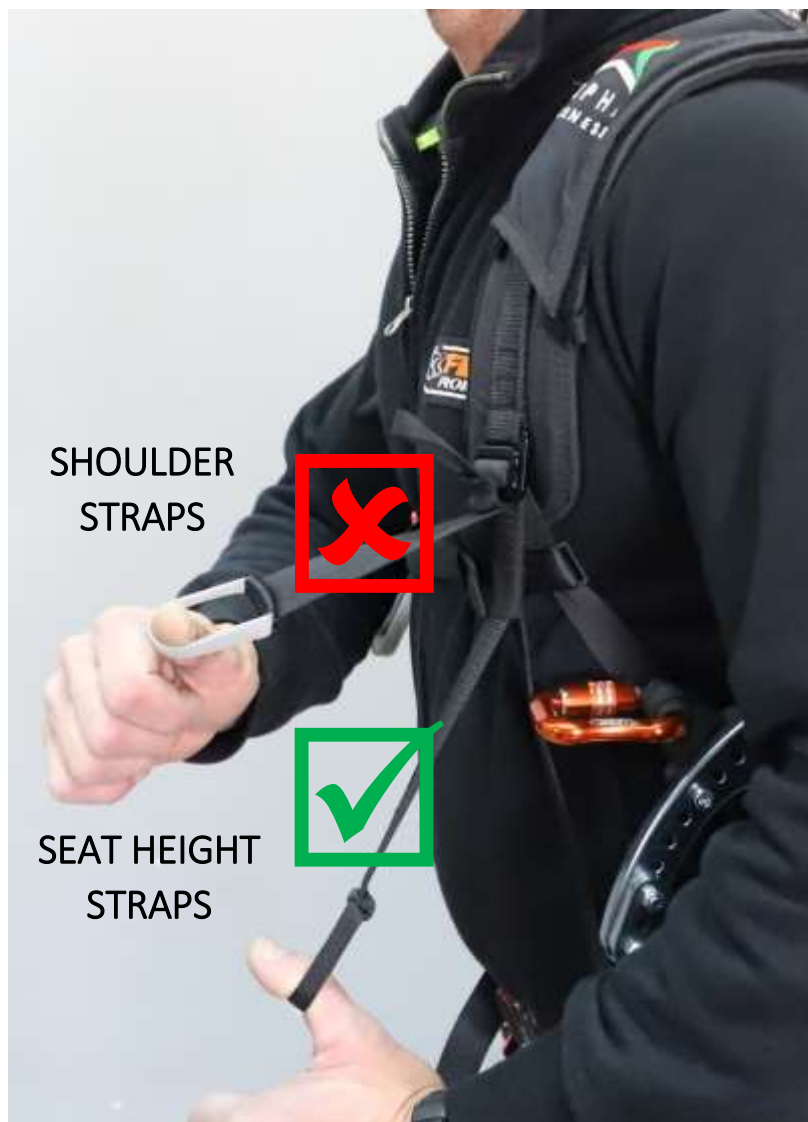

SHOULDER STRAPS

SEAT HEIGHT STRAPS

## ASC<sup>EVO II</sup> PIVOT ARMS ADJUSTEMENTS



The first rule to be observed is the position of the attachments according to the direction of the fixing screws.

The bolt heads are positioned inside and the nuts on the outside of the arms, this to avoid wear of the harness by rubbing the parts.



Do not over tighten these nuts to avoid weakening the structure and therefore the seal!

Preferably use a torque wrench calibrated at **10 N-m** (Newton / meter) which correspond to about **1 Kg. (2.2 lb)**



## SETTING # 1: THE TORQUE

Most important setting is the torque compensation setting.  
The torque is generated by the propeller rotation direction.

There are two types:

ANTICLOCKWISE/LEFT in engines with BELT reduction such as the **MOSTER**  
CLOCKWISE/RIGHT in motors with MECHANICAL reduction

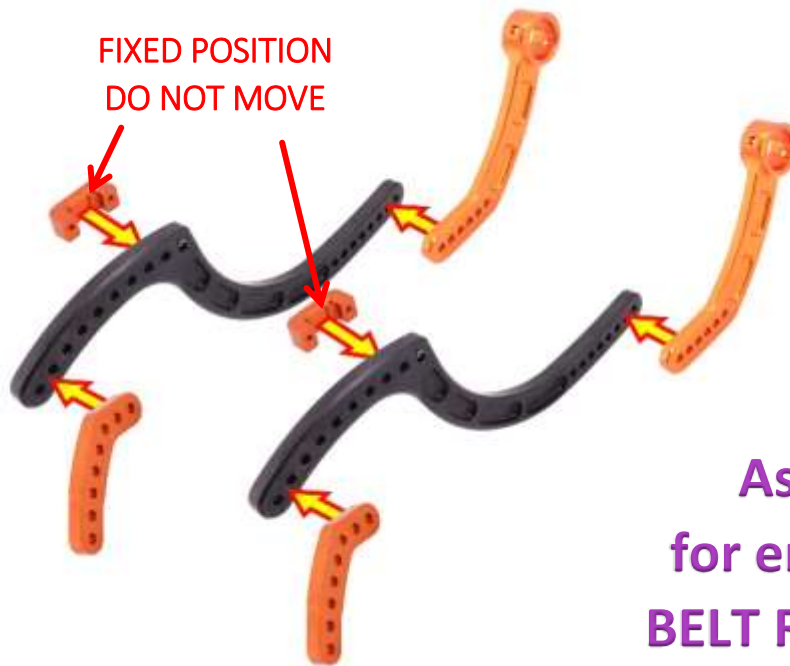

Assembly  
for engines with  
BELT REDUCTION

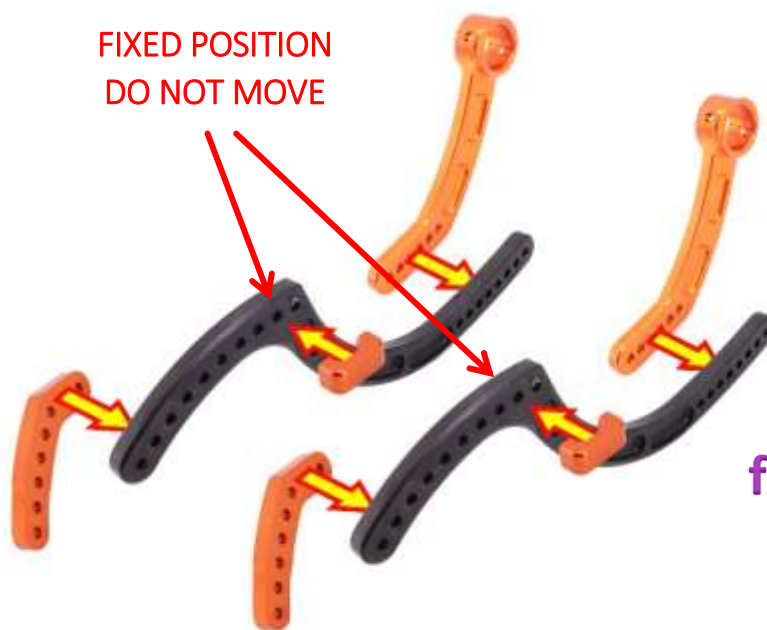

Assembly  
for engines with  
MECHANICAL  
REDUCTION

## SETTING # 2: PILOT WEIGHT



Before your first flight,  
**test the position.**

Attach the paramotor to the simulator and check the inclination which must be between **15°** and **20°**.

The harness has many adjustments through which you can find your best position of being comfortably seated.

To vary the inclination of the paramotor you need to act on the Pivot arms adjustment as detailed below.

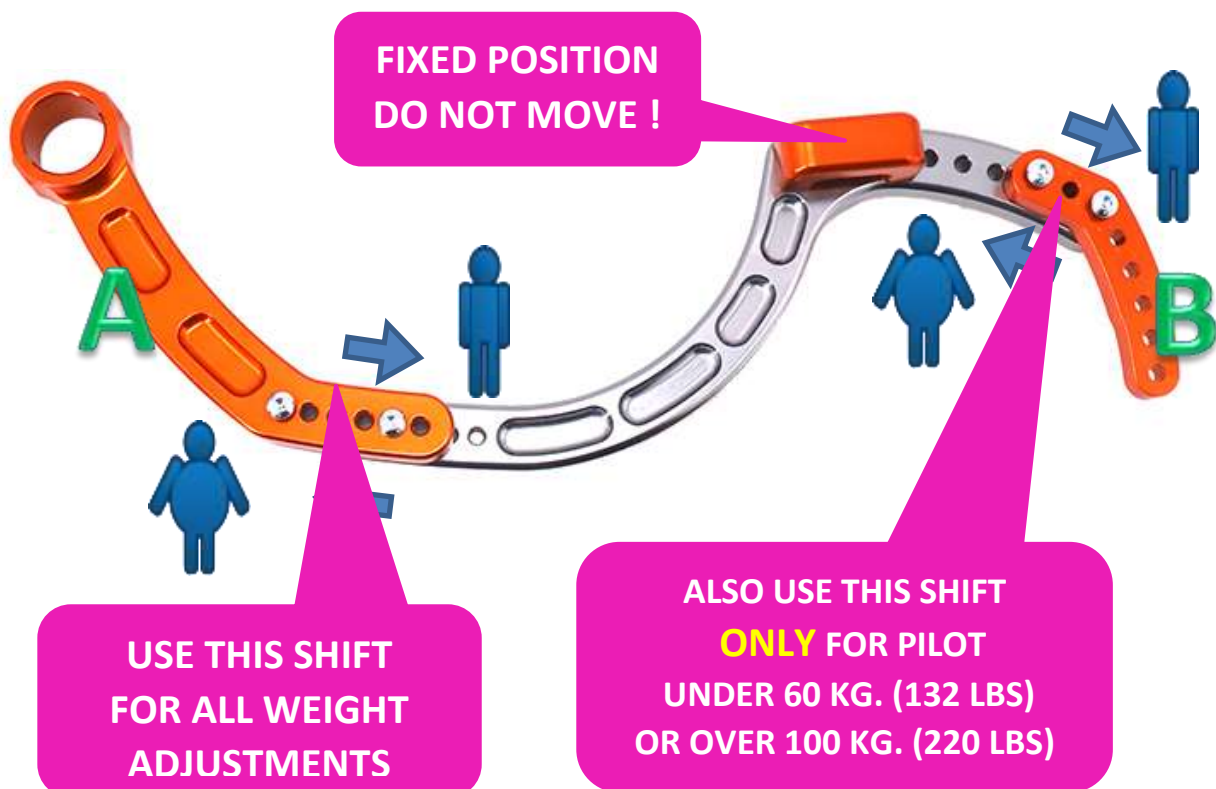



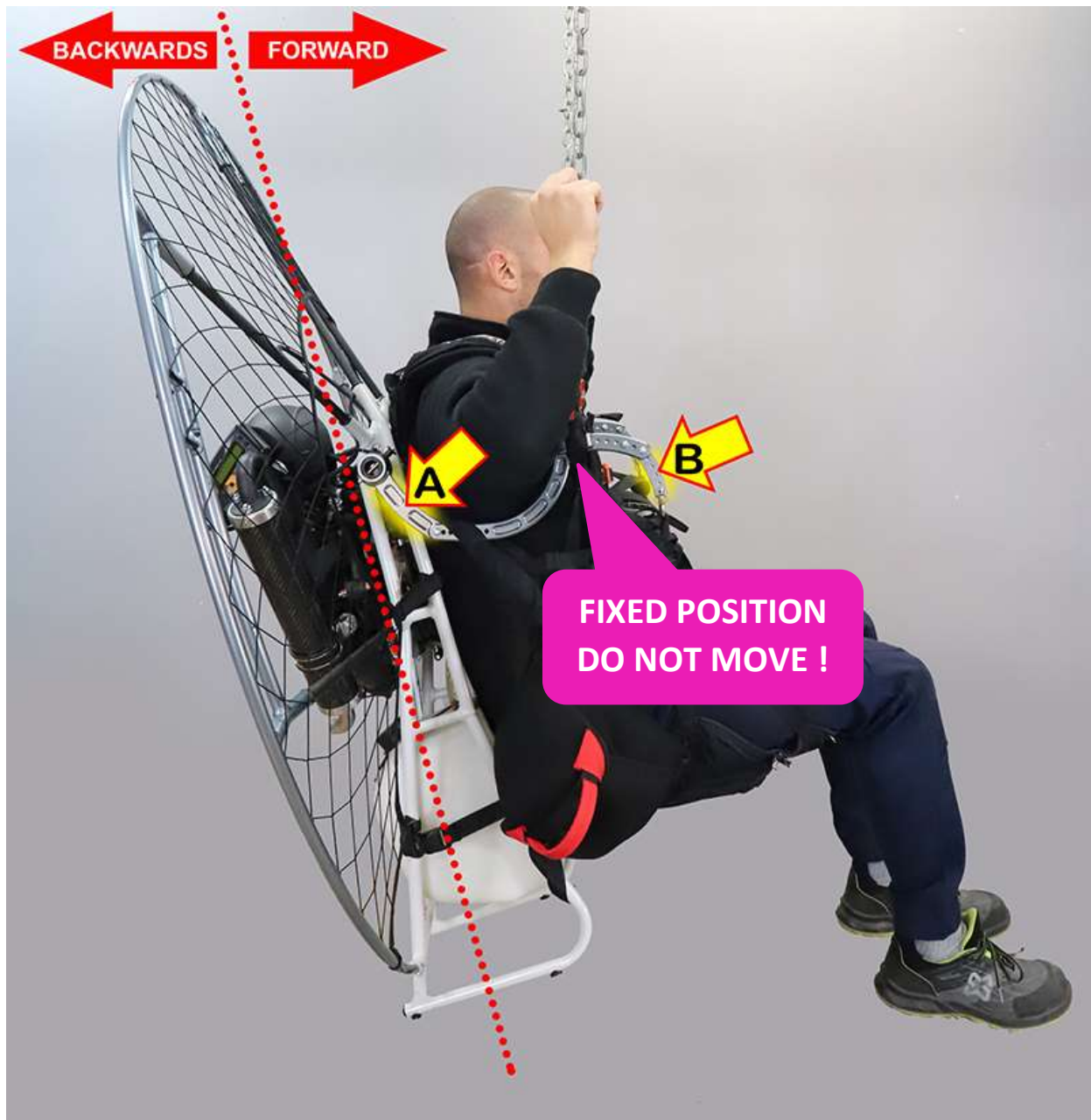

If the paramotor is tilted too far back it means that the pilot is light compared to the spacer adjustment, if the paramotor is tilted too far forward it means that the pilot is heavy compared to the spacer adjustment, The adjustment of the pilot's weight is achieved by moving the arms "A" and/or "B" of one or more holes backwards for too heavy pilots or forward for too light pilots like the image above.

Usually, it is sufficient to move only the arms "A", but for pilots under 60 Kg. (132 lbs) or over 100 Kg. (220 lbs) also move the arms "B".

## SETTING # 3: HARNESS SEAT HEIGHT



To lift the seat it can be raised further the "C" quick link of 1 hole upwards.



Another possibility to lift more the seat is to reverse and rotate the front support "B" with the possibility to raise further the quick link "C" of 1 hole up.



It is also possible to adjust the depth of the seat by blocking it in the desired position on the provided Velcro.

Since there are many factors that influence the adjustments of the pivot arms such as the weight of the pilot also relative to his height, the type of engine installed, etc., we provide below some setting diagrams with RIDER MOSTER paramotor, to be considered purely for information purposes in as soon as before flying it is essential to hangtest to adjust the paramotor setup to your individual characteristics.

Example of setup for a pilot weighing Kg. 60 (Lbs. 132 )

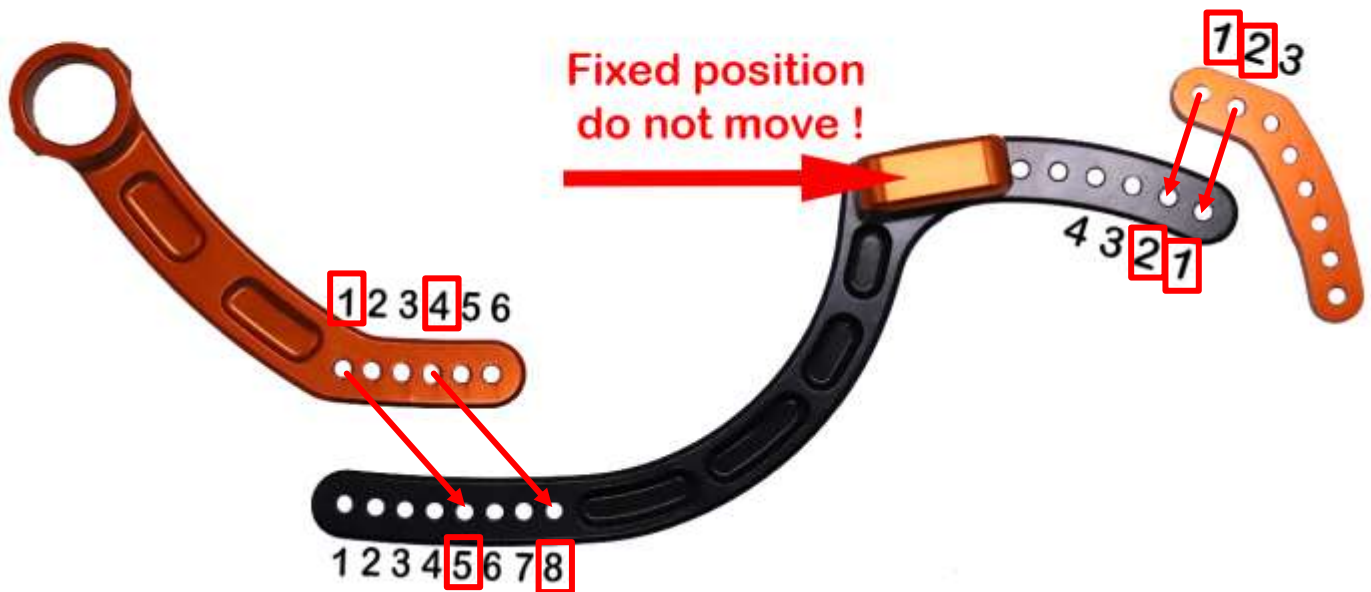

Example of setup for a pilot weighing Kg. 70 (Lbs. 154 )

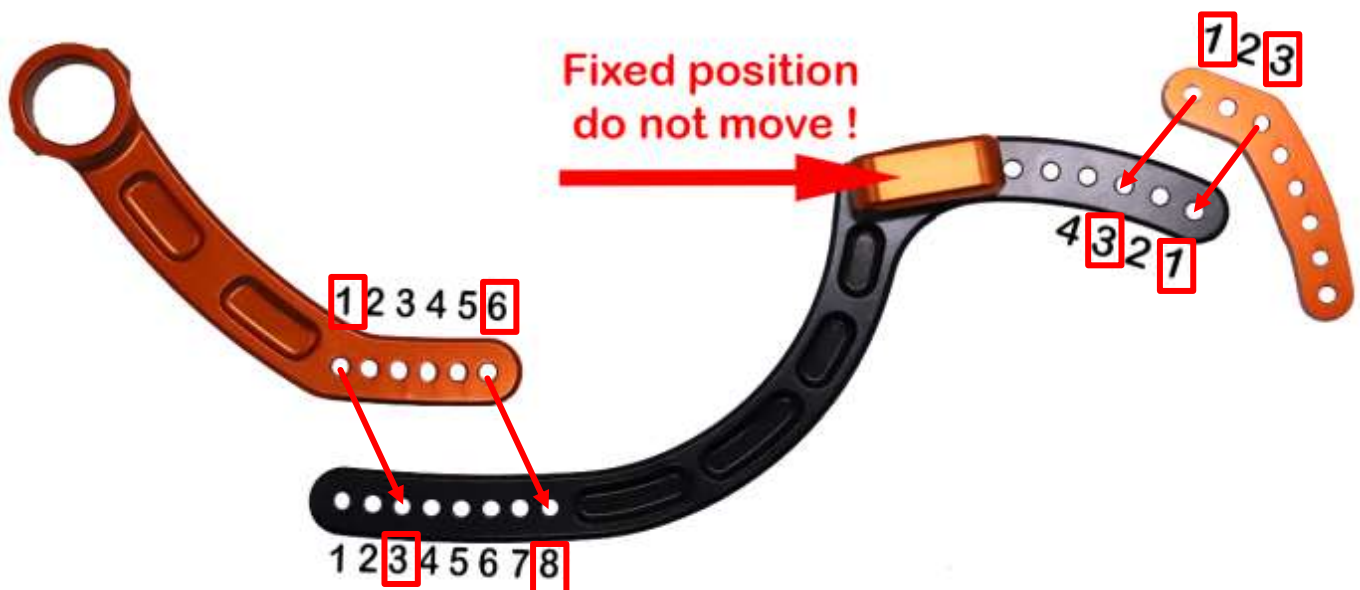

Example of setup for a pilot weighing Kg. **85** (Lbs. **187**)

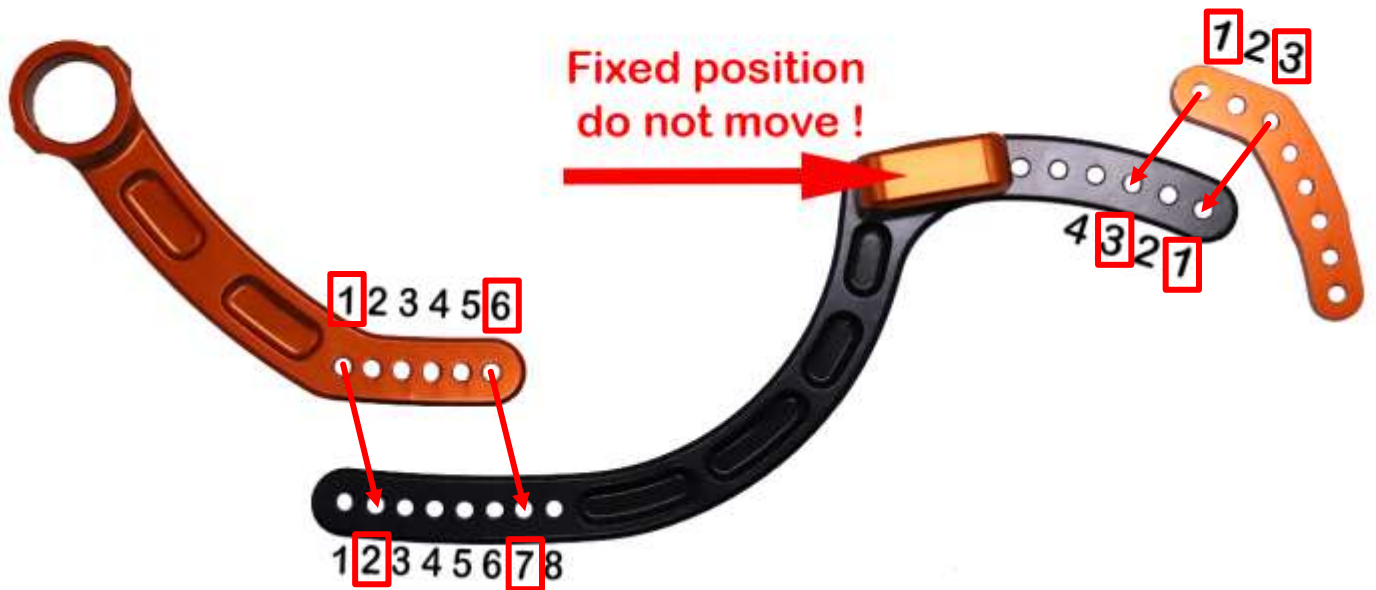

Example of setup for a pilot weighing Kg. **100** (Lbs. **220**)

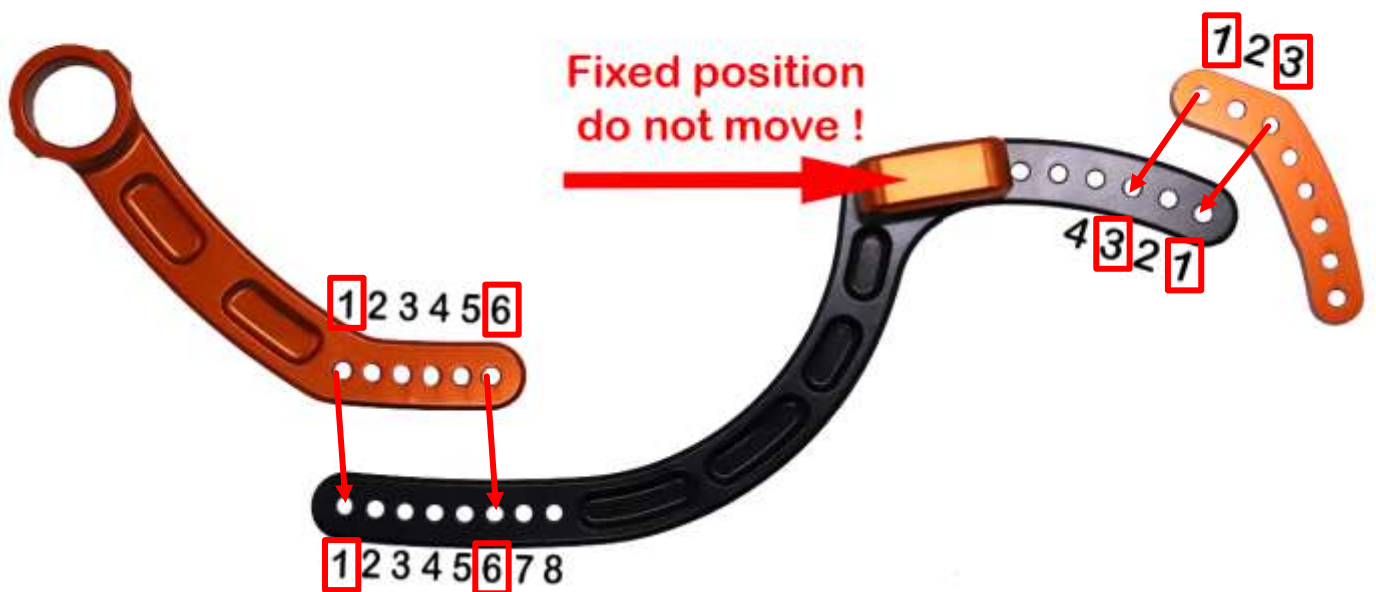

Example of setup for a pilot weighing Kg. **115** (Lbs. **253** )

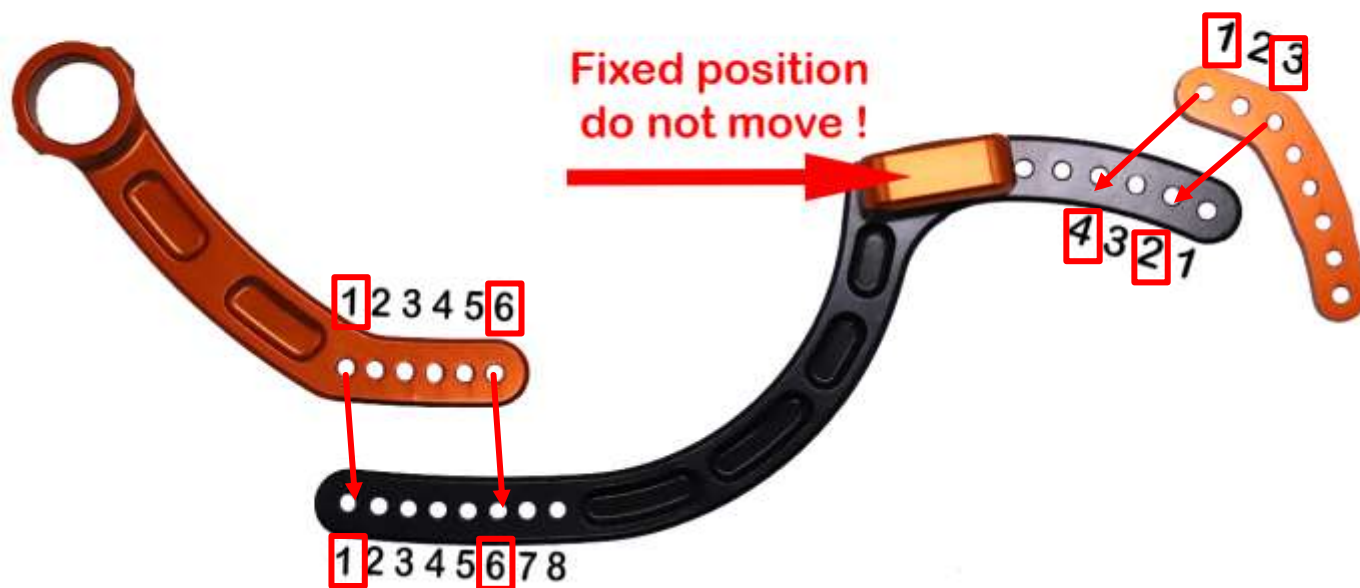

## CARABINER ATTACHMENT STRAP ASSEMBLY



To correctly assemble the carabiner attachment strap, first insert the end "C" in the loop of the harness belt hooked to the shackle.

pass the entire belt from the "A" side into the loop "C"



When all the strap has passed, tighten the loop that has formed around the harness belt loop by pulling the extremity tightly and adjusting it with your fingers.



pass side “A” into the carabiner loop attachment on the pivot arm  
and lift loop “B” until it matches loop “A”





Insert the carabiner into the loops “B” and “A” so that by rotating it remains in position with the closure facing the pilot.

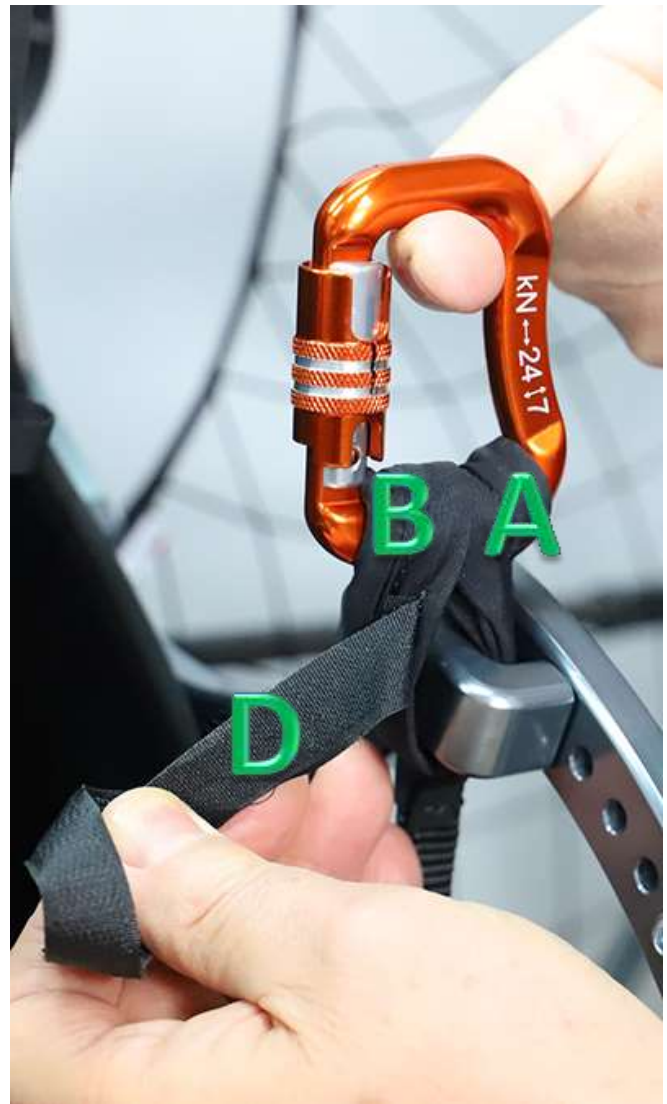

To finish assembly, wrap very tightly velcro "D" around loops "B" and "A" so that the carabiner remains in the correct position.

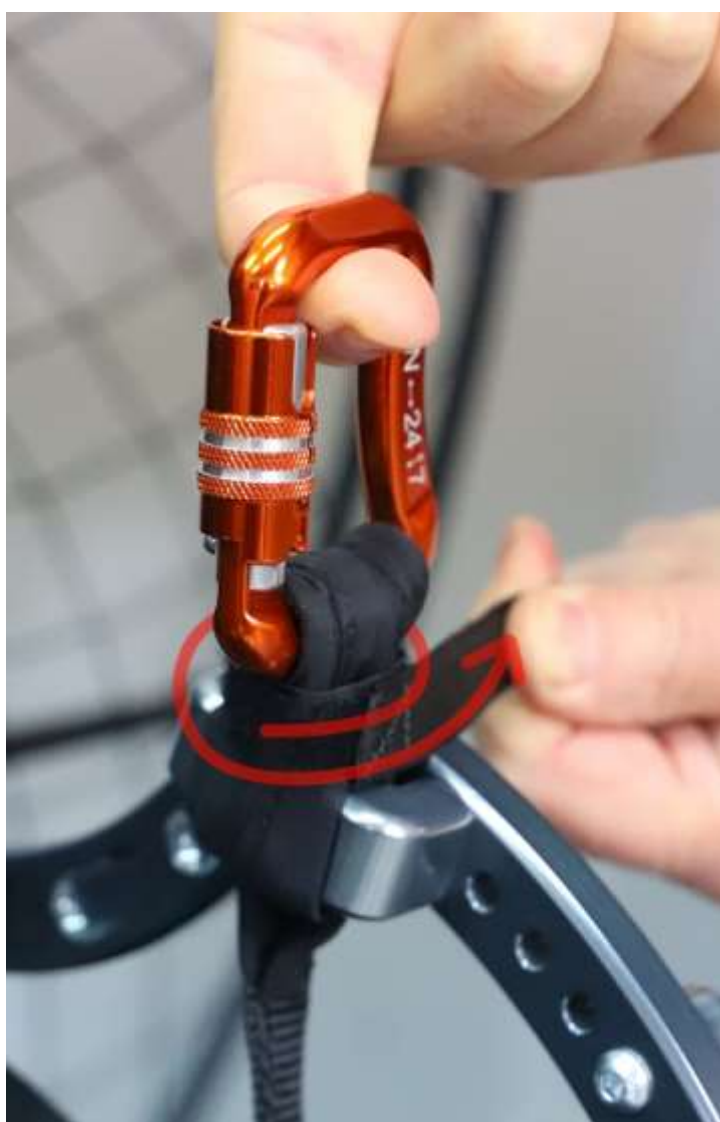

Once the carabiners have been assembled, check for correctness angle them so that they are both facing forward, as indicated below, to facilitate the pilot during take-off, landing and exiting the harness.



If one or both carabiners are facing backwards repeat the assembly correctly.



This operation completes the assembly  
of the pivot arms **ASC<sup>EVO II</sup>**

## PROPELLER ASSEMBLY



When preassembling the fiber propeller, be careful not to reverse the direction of the blades!

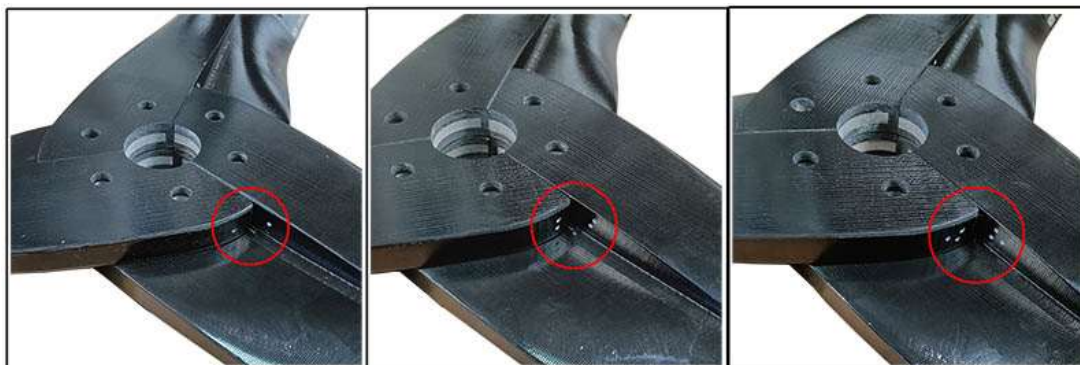

When assembling the three-blade propeller, pay close attention to the sequence indicated on the back of the propeller

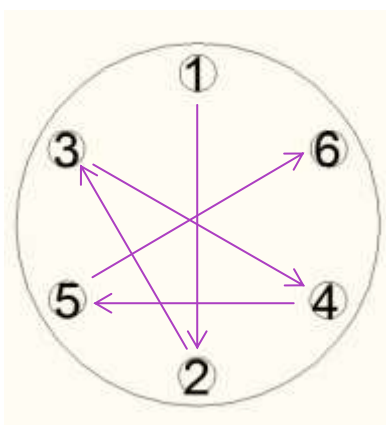

Screw all the propeller bolts without forcing. Tighten them gradually following the correct sequence as indicated.

# MULTIFUNCTIONAL HANDLE

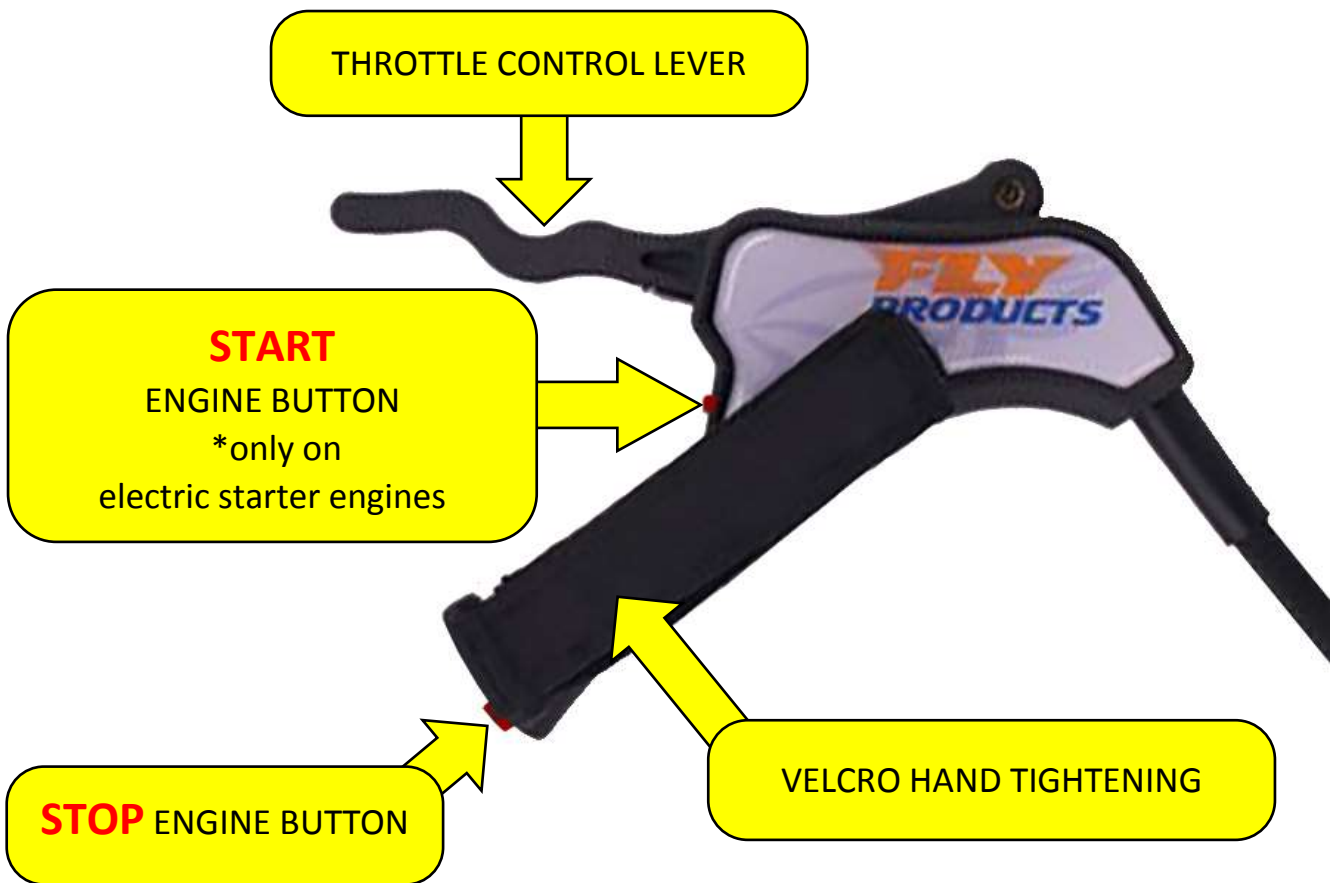

## WARRANTY

Fly Products (Seller, Our, Us) warrants the original Purchaser that this product shall be free from defects in materials and workmanship under normal use for a period of 12 months from the date of purchase. If for any reason this product is powered by fuel that does not meet the criteria stated in the engine manual, or is used with other equipment, parts or replaceable items (such as consumables) which are neither made nor approved by Fly products, Fly Products shall not be responsible for any loss of quality, degradation of performance or actual damage that results from the use of such fuel, equipment, parts or replaceable items.

Seller obligation and liability under this warranty is expressly limited to repairing or replacing, at Seller's option, any product not meeting the specifications. The dealer, from whom you purchased the product, or Fly Products, will repair the product free-of-charge. In no event shall Fly Products be liable to the Purchaser or any other person for any loss or damage whether direct or indirect or consequential or incidental, including without limitation, any damages or claims by third parties caused by defective products or otherwise arising from the incorrect or otherwise improper use of this product. This warranty applies only to defects in parts and workmanship relating to normal use. It does not cover:

- damage arising from improper maintenance or negligence
- damage caused by incorrect pilot operation
- damage caused by wind or adverse weather conditions
- fair wear and tear

Fly Products shall, at its option, repair or replace any defective products. Improper use, that is, use for purposes other than those mentioned in this manual will void the warranty.

Limited warranty Fly Products shall not be liable to the Purchaser or any other person for damage arising from improper storage, handling or use of this product. Repairs to this Product must be carried out by qualified technicians appointed by Fly Products. This Product must be assembled in accordance with the instructions in this manual.

To obtain warranty service, please contact your dealer or Fly Products directly. Shipping charges are the responsibility of the purchaser.



© Copyright by **FLY Products** s.r.l.  
Via Perù n. 30 - 63066 GROTTAMMARE (AP) - ITALY tel./fax +39.735.632486  
www.flyproducts.com - ✉ fly@flyproducts.com